



# PANTERA ECO

## VARIABLE SPEED POOL PUMP

### OWNER'S MANUAL



Should the installer or owner be unfamiliar with the correct installation or operation of this type of equipment you should contact the distributor/manufacturer for the correct advice before proceeding with the installation or operation of this product. The pump operator or owner must be provided with this owner's manual.

## ECO SELECT®

---

The Eco Select® brand identifies our most eco-friendly products.

As the global leader in pool and spa equipment, we've made a strong commitment to develop and offer the most environmentally responsible products available.

When you see the Eco Select® brand on one of our products, you'll know it is our "greenest" and most efficient product in that equipment category.

These products do the best job of saving energy, conserving water, reducing noise, or otherwise contributing to a more environmentally responsible equipment system. In every case, a product that earns the Eco Select brand is clearly our "greenest" and most efficient choice.



# TABLE OF CONTENTS

---

	Page
<b>Features and Benefits</b>	4
<b>Technical Information</b>	5
Model Data	5
Hydraulic Performance	6
Dimensions	6
<b>Installation</b>	7
Pump Positioning	6
Piping	8
Pool Outlets	8
Electrical	9
Equipotential Bonding	9
<b>Operation</b>	10
Priming the Pump	10
Speed Selection	11
Variable Speed Adjustment	11
Priming	12
<b>Service &amp; Maintenance</b>	13
<b>Troubleshooting</b>	14
Troubleshooting Guide	14 - 15
Motor Fault Code	16
<b>Spare Parts</b>	17 - 18

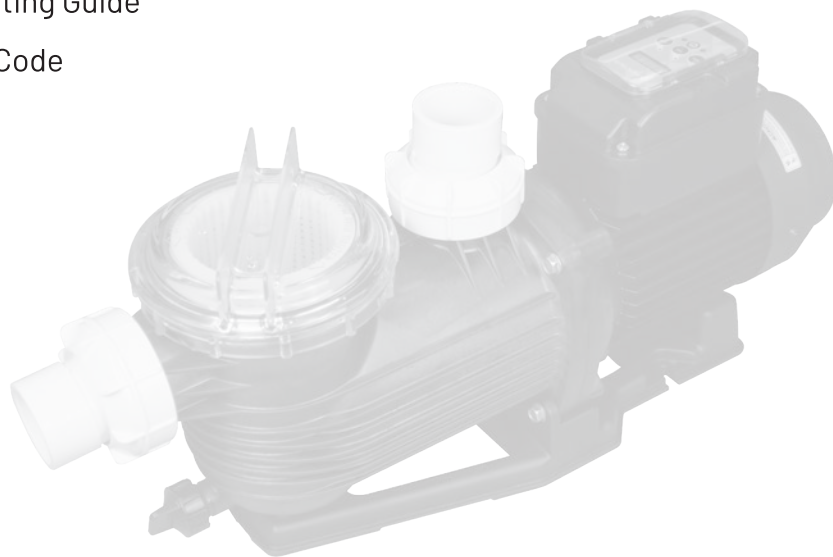

## FEATURES & BENEFITS

---

The Pantera Eco is the ideal pump for new or existing pools. Utilising advanced hydraulic design and the latest technology in permanent magnet, variable speed motors, the Pantera Eco has the perfect combination of efficiency and performance. The Pantera Eco delivers energy savings and the power when you need it. You will also have the peace of mind that you are doing your bit for the environment and reducing your carbon foot print.

- Variable speed pump, with 3 programmable speeds, allows you to effortlessly select the most efficient setting to meet you filtration, cleaning and water feature needs.
- Axial flux, brushless permanent magnet motor delivers high efficiency and low noise levels.
- Fault protected motor prevents damage by automatically shutting down the motor in the event of a locked rotor, under voltage, over voltage or over current condition and will automatically reduce the speed during an over temperature condition.
- Pantera pumps are built with 5 levels of corrosion resistance including the plastic yoke and lip seal which protects the motor from water damage.
- A heavy-duty construction and a motor rated for continuous operation make the Pantera Eco a tough, long-lasting performer.
- Unique self-aligning barrel unions fit to askew plumbing. 40mm internal / 50mm external spigot (AS/NZS PVC Pressure Pipe).
- Adjustable priming speed and duration up to 2 hours.

## TECHNICAL INFORMATION

---

### Model Data

<b>RPM:</b>	Low 1450RPM (default factory setting) Med 2400RPM (default factory setting) High 2850RPM (default factory setting) Adjustable Range: 1000-2850RPM
<b>Electrical Rating:</b>	230-240V 50Hz single phase
<b>Rated Current:</b>	Low: 1.4A (max) Med: 4.5A (max) High: 6.0A (max)
<b>Input Power (P<sub>1</sub>):</b>	Low: 165W (max) Med: 590W (max) High: 945W (max)
<b>Output Power (P<sub>2</sub>):</b>	Low: 135W (max) Med: 475W (max) High: 800W (max)
<b>Maximum Ratings:</b>	2850RPM, 945W, P2 800W, 6.0A
<b>IP Rating:</b>	IP25
<b>Inlet (Suction):</b>	ABS Barrel Union to suit 40mm* PVC pressure pipe to AS/NZS 1477
<b>Outlet (Discharge):</b>	ABS Barrel Union to suit 40mm PVC pressure pipe to AS/NZS 1477
<b>Maximum Total Head:</b>	17m
<b>Water Temperature Range:</b>	5°C – 40°C
<b>Maximum Ambient temperature:</b>	50°C
<b>Recommended pH Range:</b>	7.2 - 7.8 (Guide Only)
<b>Motor:</b>	Axial flux, permanent magnet, DC
<b>Protection:</b>	Mains over voltage, mains under voltage, over temperature, under temperature, locked rotor, over current, phase disconnect.
<b>Supply cord:</b>	10A, H07RNF, 2m.

\*Fits to 50mm AS/NZS pressure pipe spigot. Use a 50mm coupling or 50mm elbow for connection.

# TECHNICAL INFORMATION

## Hydraulic Performance

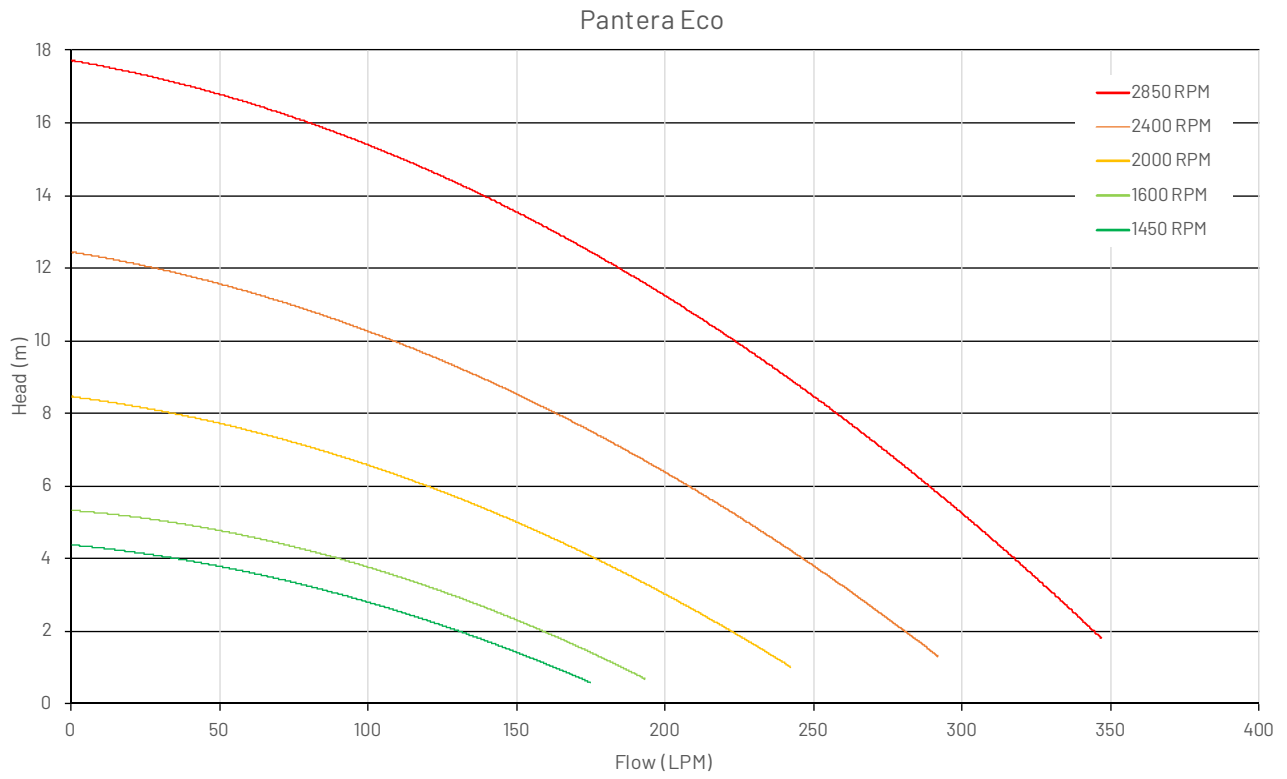

## Dimensions

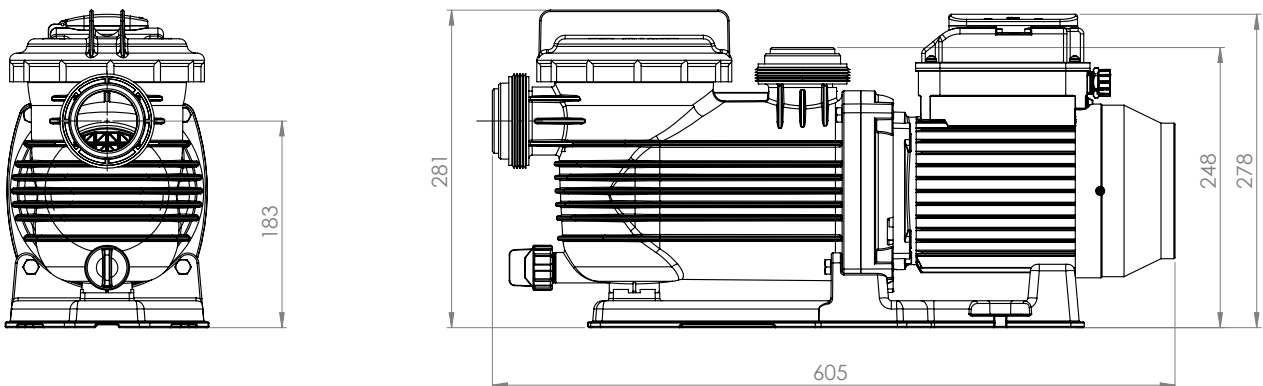



The pump must be installed and serviced by a suitably qualified person in order to avoid hazard. Incorrectly installed or tested equipment may fail, causing severe injury or property damage.



These instructions are a guide only. Should you the installer or owner of the product be unfamiliar with the correct installation or operation of this product you should contact a suitably qualified person for advice.



Do not connect system to high pressure or mains water system.



This pump is not intended for use by persons (including children) with reduced physical, sensory or mental capabilities, or lack of experience and knowledge, unless they have been given supervision or instruction concerning use of the appliance by a person responsible for their safety.



Children should be supervised to ensure that they do not play with the pump.



The Pantera Eco is electrically connected. Ensure that it is isolated from electrical supply during installation and any subsequent service work.

## 1. Plan the position of the pump



**For best performance, allow pump suction inlet height to be as far below water level as possible and allow the use of short, direct suction pipe with minimum bends (to reduce friction losses).**

- a.** Have enough ventilation to keep ambient temperature below the motor's rated ambient temperature whenever the pump is running. If installed in an enclosure/pump house, the enclosure must have adequate ventilation (200sq.cm min, inlet & outlet) and air circulation Allow 200mm to keep rear of motor clear.
- b.** Have adequate floor drainage to prevent flooding and be protected from excess moisture.
- c.** Be solid, level, rigid and vibration free.
- d.** To reduce vibration and pipe stress, bolt pump to mount. Fixing holes accept 12mm fasteners.
- e.** Be within 2m of a power outlet for electrical connection (refer to AS/NZS 3000 for rules regarding connection of electrical equipment in pool zones).
- f.** Allow adequate access for servicing pump and piping.

# INSTALLATION

---

## 2. Piping



**For best performance, allow pump suction inlet height to be as far below water level as possible and allow the use of short, direct suction pipe with minimum bends (to reduce friction losses).**

- a.** Use only Australian Standard PVC pressure pipe. For best performance use at least 40mm diameter pipe for all connections to the pump. Never use a suction pipe smaller than pump suction connections (40mm) and use larger pipe for long suction distances.
- b.** To avoid stress on the pump, support both suction and discharge pipes independently. Place these supports as close to the pump as possible.
- c.** To avoid a strain left by a gap at the last connection, start all piping at the pump and run pipe away from the pump.

## 3. Pool Outlets



- a.** The pump suction system must provide protection against hazard of suction entrapment or hair entrapment/entanglement. The pool outlet piping must be in accordance with the latest AS1926.3 standard.
- b.** Suction outlet covers and skimmers must have been tested and found to comply with the latest AS1926.3 standard or ASME/ANSI specification for Suction Fittings.

## 4. Electrical



Do not use extension leads as they are unsafe in and around the Pool Zone.



Hazardous voltage. Can shock, burn or cause death.



To avoid dangerous or fatal electrical shock, turn OFF power to pump and remove plug from outlet before working on electrical connections.

- a. Electrical installation shall be in accordance with the national wiring rules (AS/NZS 3000) taking into account its ratings (Class I, IPX5). The pump is supplied with a standard Australian 10 amp plug and 2 metres of cord. Select the correct Pool Zone for installation.
- b. An RCD with maximum rated residual current of 30mA is required for the power supply to the pump. Additionally, if a suitable socket outlet is not available a weatherproof socket must be installed by an electrician in a suitable location. RCD tripping indicates an electrical problem. If RCD trips and will not reset have a qualified electrician inspect and repair electrical system.
- c. Incorrect voltage can cause fire or seriously damage pump and voids warranty.
- d. Voltage at pump must not be more than 6% above or 10% below motor nameplate rated voltage or pump may overheat, causing overload tripping and reduced component life. If voltage is less than 90% or more than 106% of rated voltage when pump is running at full load, consult the power company.

## 5. Equipotential bonding

If equipotential bonding is required, connect all metal parts of the swimming pool or spa structure and to all electrical equipment, metal conduit, and metal piping in accordance with the wiring rules. Run a wire from the equipotential bonding terminal on the pump (bottom, left motor bolt with serrated washer) to the pool bonding structure.

# OPERATION

---



NEVER run pump dry. Running pump dry may damage seals, causing leakage and flooding. Fill pump with water before starting motor.



Freezing conditions will damage the unit, as water expands as it freezes. Ensure that the Pantera Eco is located so that it is not prone to freezing, or ensure that the product is disconnected and dried of water during cold conditions.



Trapped air in system can cause explosion. Ensure all air is out of the system before operating or testing equipment.



Fire and burn hazard. Modern motors run at high temperatures. To reduce the risk of fire, do not allow leaves, debris, or foreign matter to collect around the pump motor. To avoid burns when handling the motor, let it cool for at least 20 minutes before trying to work on it.



Small children using pool must ALWAYS have close adult supervision.



Pump suction is hazardous and can trap and drown or disembowel bathers. Do not use or operate pump, pool/spas if a suction outlet cover is missing, broken, or loose. Follow the guidelines below for a pump installation which minimises risk to users of pool and spas.



NEVER tighten or loosen trap lid while pump is operating.

## 1. Priming the pump







**It is not necessary to lubricate the oring. The original equipment O-ring contains a permanent internal lubricant.**

- a. Before removing trap lid, SWITCH OFF POWER SUPPLY to pump.
- b. CLOSE SHUT-OFF VALVES on suction and discharge pipes, if present.
- c. Remove the trap lid (turn anti-clockwise).
- d. Fill trap tank with water.
- e. Check the lid o-ring and sealing surface, ensure there is no dust or debris on either, and replace the lid (turn clockwise to tighten by hand only - no wrenches!).
- f. Open the shut-off valves on the suction and discharge pipes, if present.
- g. Release all air from filter, pump and piping system (refer filter owner's manual). In a flooded suction system (water source higher than pump), pump will prime itself when suction and discharge valves are opened and air is released.
- h. Switch on power to the pump to start.
- i. Pump should start to prime now. Priming time will depend on vertical height of suction lift and horizontal length of suction piping but is generally between 30 seconds to 3 minutes under normal installation conditions.
- j. The Pantera Eco will start slowly but ramp up to high speed for the first 2 minutes to assist priming. It will then switch to the selected speed.

## 2. Speed Selection











The Pantera Eco VS 800 comes pre-programmed with the following default speeds:

	Press for low speed	Press for medium speed	Press for high speed
	 <b>1450RPM</b>	 <b>2400RPM</b>	 <b>2850RPM</b>
	<ul style="list-style-type: none"> <li>Filtration and water circulation.</li> </ul>	<ul style="list-style-type: none"> <li>Cleaning with a suction cleaner.</li> </ul>	<ul style="list-style-type: none"> <li>Backwashing filter.</li> <li>Operating some water features such as jets or waterfalls.</li> <li>Solar heating</li> </ul>

Press to turn power on/off. If power is removed, motor will return to the last speed selected when power is restored. Motor will remember ON/OFF state.











## 3. Variable Speed Adjustment

If the default speed settings do not perfectly match the particular installation. They can be adjusted as follows.

1.	 ,  <b>or</b> 	Press and hold button corresponding to speed you wish to change. Hold for 3 seconds and a light should begin to flash.
2.		To decrease speed by 50rpm increments with 1000rpm as the minimum limit.
		To increase speed by 50rpm increments with 2850rpm as the maximum limit.
3.		To save the current speed setting and return to normal operation mode.
		Will cancel the change and revert back to the original speed and return to normal operation mode.
	 +  + 	Holding all 3 buttons for 3 seconds will reset the speeds to default.

# OPERATION

## 4. Priming

Disable or Enable the Prime Time		Press the "STOP" button for 5 seconds to DISABLE/ENABLE prime time. (The power LED/ Green will light up and not blink when prime time is disabled), this function will be back to default when reset to default or press again this button for 5 seconds.
	 ,  or 	Pressing any two of the speed buttons simultaneously to finish priming time as temporarily.
Priming time and Priming speed setup		Pressing the "STOP" button for 10 seconds the power LED/ green will blink twice in every one second then display will show "P 2" and ready to adjust time (Limit time to 240min maximum and minimum for 1Min).
		Pressing the button "low" will lower the time by 1 min step (Holding for 2 seconds to decrease time continuously).
		Pressing the button "high" (will rise the time by 1 min step (Holding for 2 seconds to increase time continuously).
		Pressing the button "med/set" will save the new time then automatic go to Priming speed setup in next step and display show "2850" and ready to adjust speed.
		Pressing the button "low" will lower the speed by 25 RPM step (Holding for 2 seconds to decrease speed continuously).
		Pressing the button "med/set" will save.

## SERVICE & MAINTENANCE







To avoid dangerous or fatal electrical shock hazard, turn OFF power to pump and remove plug from power outlet before working on pump.



Do not operate pump with trap basket missing or damaged.

- It is essential for the longevity of the pump that regular service and maintenance be carried out. The Pantera Eco VS 800 incorporates high velocity moving parts and is pumping water containing harsh pool chemicals. Some parts which will wear during the normal operation and expected life of the pump.

FREQUENCY	
Once per week	Once per month
<b>CHECK</b>	
 <p>Inspect trap basket, and empty of any leaves and other debris. Leaves and other debris that collects in basket will choke off water flow through the pump and reduce efficiency and performance. See below instructions on cleaning the trap.</p>	 <p>Check the pump to ensure no water is leaking from inlet and outlet joints, whilst pump is operating. If leaks are noticed, clean and grease the o-rings or replace if necessary.</p>
 <p>Clean area around pump and ensure there are no leaves or debris which could become a fire hazard or choke the motor fan.</p>	 <p>Check that there are no leaks from under the pump. If there are, this could be a sign of a leaking mechanical seal. Call a Pentair Service Agent immediately, to prevent damage to the motor.</p>
	 <p>Check pump and motor for insects and pest infestations and ensure that motor fins are clean of dust and dirt. Clean if necessary.</p>

Follow instructions below to clean trap:

- Switch off power to pump, close valves in suction and discharge, and release all pressure from system before proceeding.
- Remove trap cover (turn counter clockwise). If necessary, tap handles gently with a rubber mallet.
- Remove strainer basket and clean. Ensure all holes in basket are clear, flush basket with water and replace in trap with large opening at pipe connection port (between ribs provided). If basket is replaced backwards, the cover will not fit on trap body. To clean transparent cover, use water and neutral soap only. Do not use solvents.
- Clean and inspect lid o-ring; reinstall on trap. Clean O-ring groove on trap body and replace cover. To help keep cover from sticking, tighten hand tight only.
- Prime pump (refer priming instructions).

# TROUBLESHOOTING



The Pantera Eco VS 800 should only be serviced by certified Pentair service agents. For best results and to ensure warranty is not void, insist on use of only genuine Pentair service parts.



To avoid dangerous or fatal electrical shock hazard, turn OFF power to pump and remove plug from power outlet before working on pump.



The power supply cord has a type 'Y' attachment and if service is required to the power cord, it must be replaced with the specialised power cord assembly by Pentair Water service agent or similarly qualified personnel in order to avoid a hazard. Warranty is void if unauthorised modifications are made to any component.

## Troubleshooting Guide

SYMPTOM	CAUSE	REMEDY
<b>Low water pressure, low flow from pump.</b>	<b>Suction leaks / lost prime.</b>	<ul style="list-style-type: none"> <li>• Pump must be primed; make sure that the pump casing and strainer are full of water. Refer priming instructions.</li> <li>• Make sure there are no leaks in suction piping and ensure all o-rings are present and clean.</li> <li>• Make sure suction pipe inlet is well below the water level to prevent pump from sucking air.</li> <li>• Suction lift of 3 to 6 metres will reduce performance. Suction lift of more than 6 metres will prevent pumping and cause pump to lose prime. In either instance, move the pump closer (vertically) to water source. Ensure that the suction pipe diameter is large enough.</li> </ul>
	<b>Low speed setting.</b>	<ul style="list-style-type: none"> <li>• Check speed setting. Refer to speed selection section of this manual. Reset to default if necessary.</li> </ul>
	<b>Clogged pipe / strainer / impeller / filter system.</b>	<ul style="list-style-type: none"> <li>• Ensure trap is not clogged with debris; clean basket and/or filter.</li> <li>• Make sure that the impeller is not clogged. This should be checked by qualified personnel only.</li> <li>• Pump may be trying to push too high a column of water. If so, a higher pressure pump is required.</li> </ul>

## TROUBLESHOOTING

SYMPTOM	CAUSE	REMEDY
<b>No water coming from pump (pump is working).</b>	<b>Air ingress to system.</b>	<ul style="list-style-type: none"> <li>• Prime the pump. Check that there are no air leaks in the suction piping or fittings. Ensure the strainer lid is airtight and fitted securely. Ensure all o-rings are present.</li> </ul>
<b>Pump does not work.</b>	<b>Motor fault.</b>	<ul style="list-style-type: none"> <li>• Refer to motor fault codes.</li> </ul>
	<b>No power at outlet.</b>	<ul style="list-style-type: none"> <li>• Use another electrical appliance that is known to work to check power outlet.</li> </ul>
	<b>Blown fuse / Circuit breaker.</b>	<ul style="list-style-type: none"> <li>• Check and call electrician if necessary.</li> </ul>
<b>Pump running too slow.</b>	<b>Low speed setting.</b>	<ul style="list-style-type: none"> <li>• Check speed setting. Refer to speed selection section of this manual. Reset to default if necessary.</li> </ul>
	<b>Motor high temperature limit exceeded.</b>	<ul style="list-style-type: none"> <li>• Ensure motor fins are clean and fan is intact and free from blockages. Ensure adequate ventilation and reduce ambient temperature.</li> </ul>
<b>Water leaking from between the casing and motor.</b>	<b>Casing bolts are not tightened sufficiently; worn mechanical seal requires replacing.</b>	<ul style="list-style-type: none"> <li>• Switch off the power to the pump. Tighten the casing bolts or replace the mechanical seal as required.</li> </ul>

Should problems persist, contact your nearest Pentair Water Service Agent.

# TROUBLESHOOTING



The variable speed motor is a sophisticated and highly technical device. Should a fault occur with the motor, it cannot be serviced and must be replaced by a certified Pentair service agent or similarly qualified personnel in order to avoid a hazard. Warranty is void if unauthorised modifications are made to any component.

- If a fault develops with the motor, an error code will be displayed as per the following table. Faults can be cleared by resetting power to the motor. If faults persist contact your Pentair service agent.

MOTOR FAULT CODE							
E01	E02	E03	E04	E05	E06	E07	E08
Micro-controller failure	Mains under voltage	Over Temp.	Over Current	Mains over voltage	Output shaft seized	Self check failed	Motor fault
Microcontroller is continually rebooting.	The mains voltage has dropped below 180VAC.	Motor temp. has exceeded max. limit. Speed will reduce until motor returns to acceptable temp.	Over current protection has tripped. Speed will reduce until motor returns to acceptable condition.	The mains voltage has risen to above 269VAC.	Motor shaft seized due to blockage in pump or fan.	One or more of the self-tests failed during start up or while running.	One or more of the phases has become D/C.

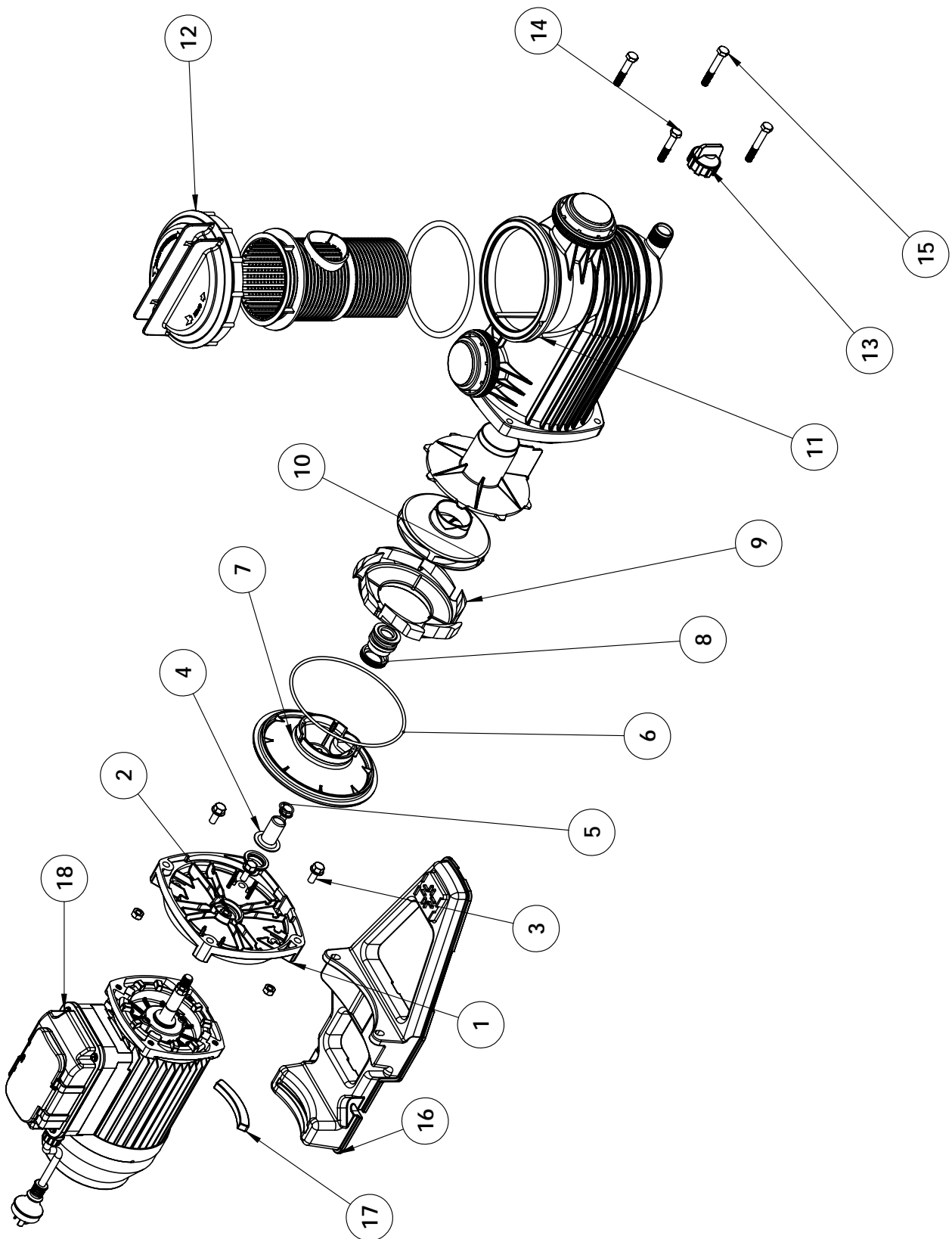

## SPARE PARTS

Item No.	Part Number	Description
1	412050	Yoke & lip seal assembly
2	See Fasteners Kit	Nut 5/16inw hex st/st
3	See Fasteners Kit	Screw 5/16inw x 3/4in hwf s/s
4	See Seal Kit	Shaft sleeve
5	See Seal Kit	O-ring bs106
6	702206K	Oring 400 600 700 900 casing ( bs258 )
7	305300	Baffle - moulded
8	800583K	Seal kit
9	305460K	Diffuser moulded
10	507530K	Impeller
11	801200K	Casing pantera pool
12	800897K	Lid & o-ring kit
13	504605	Priming cap
14	See Fasteners Kit	Bolt 5/16 in w x 1.75 In hwf
15	See Fasteners Kit	Bolt 5/16 in w x 2.25 In hwf
16	702509	Base
17	See Base	Motor pad 160x12x10 rx epdm50sh
18	801301	Motor
<b>Not Shown</b>		
	302310	Strainer Basket
	801498	Control cover
	800042	PCB Replacement

**IMPORTANT**

Please attach your sales invoice/docket here as proof of purchase should warranty service be required. Please do not return warranty form to Pentair Australia - Retain for your records.

<b>PURCHASED FROM:</b>
<b>PURCHASE DATE:</b>
<b>SERIAL NO:</b>
<b>MODEL NO:</b>



**1-21 Monash Drive | Dandenong South, VIC 3175 | Australia | 1300 137 344 | [pentairpool.com.au](http://pentairpool.com.au)**

Information contained here-in remains the property of Pentair Australia Holdings Pty Ltd under Australian copyright law. Content may not be reproduced or transmitted without our prior written permission. All indicated Pentair trademarks and logos are property of Pentair. Third party registered and unregistered trademarks/logos are the properties of their respective owners.

Disclaimer: Pentair reserves the right to change product specifications and products details.  
Product images are for reference purposes only and may not represent the actual/current product.

©2020 Pentair. All rights reserved.