

LIGHT REPLACEMENT MADE EASY

Pool & Spa Light
Replacement Guide



 Spa Electrics®

spaelectrics.com.au |



retro®

REPLACEMENT LED POOL LIGHT

iRIS

LIGHTING CONTROLLER

RM-WF



PLUG & PLAY INSTALLATION

Simply plug your Spa Electrics transformer into the base of the iRIS Wi-Fi receiver and download the app to take control of your lighting system.



IMPROVED FEATURES

Select from a spectrum of colours, adjust the speed of colour shows, and control the LED brightness to create the perfect ambience.



SET & FORGET SCHEDULING

Experience the convenience of fully customisable schedules, allowing you to automate your lighting to suit any occasion.



SUITABLE FOR NEW & EXISTING POOLS

No need to replace existing cables or transformers - Simply install a MULTIPLUS light and iRIS Wi-Fi controller to your existing pool light system.

A WORLD OF COLOUR AT YOUR FINGERTIPS

iRIS Wi-Fi is designed for use with Spa Electrics MULTIPLUS LEDs and requires the purchase of RM-WF hardware to function. See page 6 for functions & compatibility.

*Smartphone not included.



**SCAN FOR
MANUALS & GUIDES**

PRODUCT OVERVIEW

PRODUCT OVERVIEW	4
LED COLOUR GUIDE	6
REMOTES	6
GKRX RETRO-FIT GUIDE	8
AGRX R1 RETRO-FIT GUIDE	12
AGRX R2 RETRO-FIT GUIDE	14
EMRX RETRO-FIT GUIDE	16
WNRX RETRO-FIT GUIDE	18
ADAPTORS	19
TRANSFORMERS	20
CABLE INSTALLATION	21
MULTIPLUS OPERATION	22
MULTIPLUS COMPATIBLE CONTROLLERS	23
MULTIPLUS ADVANCED OPERATION	24
IRIS WI-FI (RM-WF) INSTALLATION	26
IRIS WI-FI (RM-3) INSTALLATION	28
GUIDES & MANUALS	29

PRODUCT OVERVIEW

Spa Electrics' award-winning range of Retro-Fit LED pool lights takes the hassle out of replacing your existing pool lights.

With over 48 years of industry experience and technical innovation, we are proud to be **Australia's Underwater Lighting Specialists**. We are committed to delivering premium products, backed by our exceptional service.

TRANSFORM YOUR POOL WITH STUNNING LED COLOUR IN AS LITTLE AS 15 MINUTES

Designed for straightforward, no-fuss installation, the Spa Electrics Retro range caters to surface mounted and recessed lights with only a few instances requiring additional parts & adaptors.

Spa Electrics' signature MULTIPLUS LED is also compatible with major brand pool controllers, ensuring seamless integration into your existing setup.

Simply find your existing lights within this guide to identify the correct replacement, install and enjoy!



AGRX SERIES			
Type	LED Option	Part Number	Rim Colours
STANDARD NICHE	MULTIPLUS	AGRX L12 R1 CMP	C / W / G
MINI NICHE	MULTIPLUS	AGRX L12 R2 CMP	C*

*White & Grey Rims sold separately.



EMRX SERIES			
Type	LED Option	Part Number	Rim Colours
MINI NICHE	MULTIPLUS	EMRX L12 R1 CMP	C
MINI NICHE	BLUE	EMRX L12 R1 CBL	C
MINI NICHE	4000K WHITE	EMRX L12 R1 CW4	C

PRODUCT OPTIONS			
RIM Colour	Code	LED Colour	Code
CLEAR	C	MULTIPLUS	MP
WHITE	W	TRI-Colour	TR
BLACK	B	Blue	BL
GREY	G	4000k White	W4

AGRX R1 (STANDARD NICHE)

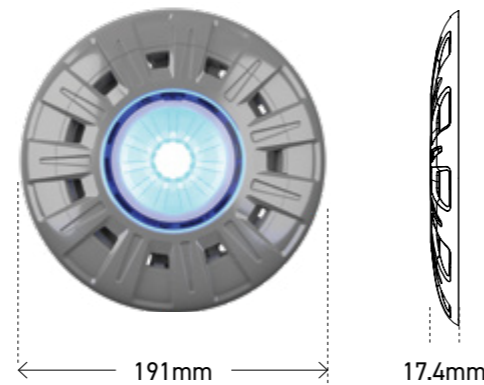

AGRX R2 (MINI NICHE)

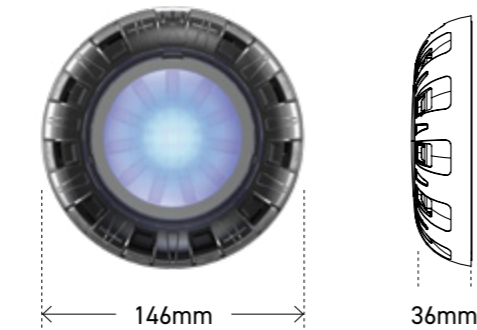

EMRX

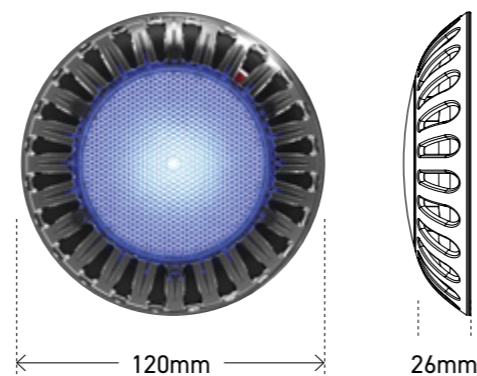

PRODUCT OVERVIEW (CONTINUED)



WNRX SERIES			
Type	LED Option	Part Number	Rim Colours
STANDARD NICHE	MULTIPLUS	WNRX L12 R1 CMP	C / W / B / G
STANDARD NICHE	BLUE	WNRX L12 R1 CBL	C / W / B / G
STANDARD NICHE	4000K WHITE	WNRX L12 R1 CW4	C / W / B / G

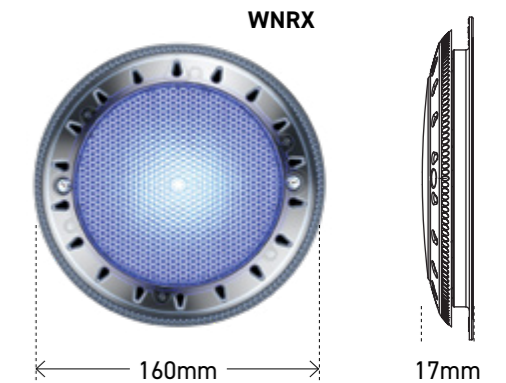

GKRX SERIES			
Type	LED Option	Part Number	Rim Colours
SURFACE MOUNT	MULTIPLUS	GKRX LMV R1 WMP	W / B / G
SURFACE MOUNT	TRI COLOUR	GKRX LMV R1 WTR	W / B / G
SURFACE MOUNT	BLUE	GKRX LMV R1 WBL	W / B / G
SURFACE MOUNT	4000K WHITE	GKRX LMV R1 WW4	W / B / G

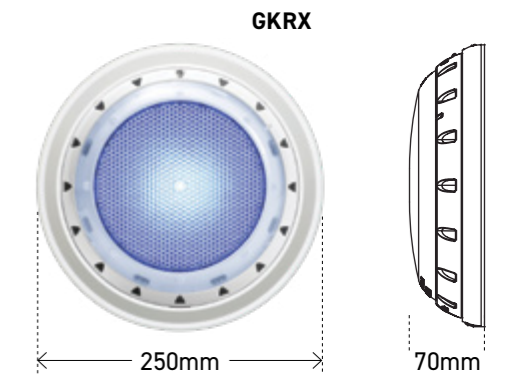

IMPORTANT NOTES

FIBREGLASS/VINYL INSTALLATIONS

Please note, for Fibreglass and Vinyl pools there are often additional steps which may include lowering the water level. Where mounting screws are used, you must lower the water level and use Neutral Curing Silicone applied to screws and in the holes to ensure it remains water tight. Special care must be taken not to remove brackets or cable glands that would compromise the pool shell/vinyl liner. Please contact Spa Electrics for detailed instructions before installing your light.

TRANSFORMERS

All* Spa Electrics Retro Fit lights require a 12V AC iron core transformer. Please check your set up prior to installing and replace transformers where necessary.

*GKRX is a multi voltage light and can function between 12-32V (AC Only)

CABLE

If the existing cable is not long enough to bring the light to the pool deck for servicing, or larger than 1.0mm² a Spa Electrics CABLE JOINER 387 and a short length of 0.5-1.0mm² cable can be used.

Where a CABLE JOINER will not fit, cable can be extended using a resin cable joint.

LED COLOUR GUIDE

MULTIPLUS

Spa Electrics' signature **MULTIPLUS** LED represents the latest in Retro-Fit multi-colour lighting. **MULTIPLUS** provides clean, white illumination and stunning, bright colours by incorporating a 4000k True White LED.

Featuring seven brilliant colours and four stunning transitions, **MULTIPLUS** is available across our entire Retro-fit lighting range. **MULTIPLUS** lights can be operated with a standard wall switch, or with the iRIS lighting control systems.

With 9 built in operating modes, **MULTIPLUS** can also integrate seamlessly with major pool automation systems.

For more information contact Spa Electrics or visit www.spaelectrics.com.au

SINGLE colour

Experience intense illumination with your choice of 2 beautiful colours to compliment your pool or spa.

Available in Blue or 4000K True White, the Spa Electrics Single Colour range is an elegant and uncomplicated lighting solution.



TRI colour

For those who love a splash of colour, the TRI Colour LED features a 4000K True White, Blue and Green.

Available only in the GKRX model, the TRI colour LED combines simplicity and flexibility, ensuring your favourite colour is available at the flick of a switch.



INCLUDED COLOURS:

- | | |
|------------|-----------------------|
| 1. White | 7. Green |
| 2. Aqua | 8. Oceanic Views |
| 3. Blue | 9. Transcendence |
| 4. Magenta | 10. Outback Australia |
| 5. Red | 11. Spring Equinox |
| 6. Lime | |

REMOTES

iRIS lighting controllers are purpose built for Spa Electrics LED Pool & Spa Lights, placing colour control in the palm of your hand.

Suitable for new and existing pools, simply select the product to match your lights and take control!

www.spaelectrics.com.au/iris-lighting-controllers

	RM-WF	RM-3	RM-2
LED Compatibility	MULTIPLUS	MULTIPLUS	All
Mobile App	✓	✗	✗
Handset	✗	✓	✓
Signal	Wi-Fi	RF	RF
Colour Selection	✓	✓	✗
Brightness Control	✓	✓	✗
Speed Control	✓	✗	✗
Schedules	✓	✗	✗
Channels/Zones	2	2	2
Additional GPO	✓	✓	✓
Batteries	-	2x AAA	2x AAA

REMOTES

iRIS LIGHTING CONTROLLERS

Spa Electrics' range of lighting controllers offers you a world of colour at your fingertips. With the elegant, purpose-built iRIS touch screen remote or your smartphone*, you can effortlessly control your pool lights, adjusting colours and brightness, and managing both pool and spa lights independently—all without leaving your seat.

KEY

- PLUG & PLAY INSTALLATION
- SET & FORGET SCHEDULING
- COLOUR & BRIGHTNESS CONTROL
- POOL & SPA CHANNEL SELECTION
- LONG RANGE RF
- SPEED CONTROL



iRIS Wi-Fi LIGHTING CONTROLLER



RM-WF - iRIS Wi-Fi

The NEW iRIS Wi-Fi controller brings colour control to the next level with new and improved features accessible direct from your smartphone. With iRIS Wi-Fi, you can select from a spectrum of colours, adjust the speed of colour shows, and control the LED brightness to create the perfect ambience. Experience the convenience of fully customisable schedules, allowing you to automate your lighting to suit any occasion.

*Smart phone not included.



iRIS LIGHTING CONTROLLER



RM-3 - iRIS REMOTE

The iRIS lighting controller allows you to take complete control of your pool lights through the elegant, purpose built iRIS touch screen remote. Change colours, adjust brightness and have independent control of your pool & spa lights, all at the touch of a button.



RM2 2 CHANNEL REMOTE CONTROLLER



RM-2 - 2 CHANNEL REMOTE

Suitable for all Spa Electrics lights, this simple, yet stylish remote allows you to power & sync your lights with ease. Simply plug your Spa Electrics Transformer into the base of the RM-2 receiver and take instant control of your lighting system.



GKRX

GKRX comes supplied with two mounting plates for Concrete (A) & Fibreglass (B) installations.

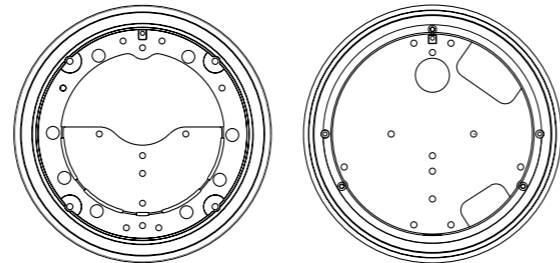
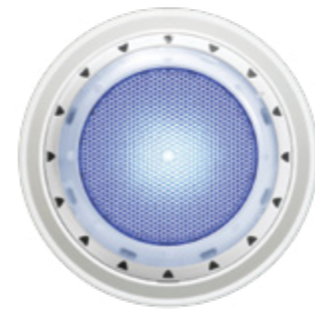

Plate A

Plate B



GKRX

RETRO KEY

- ⚡ Please check your transformer - **Must be 12V AC**
- 🔧 Please contact Spa Electrics for Installation Instructions

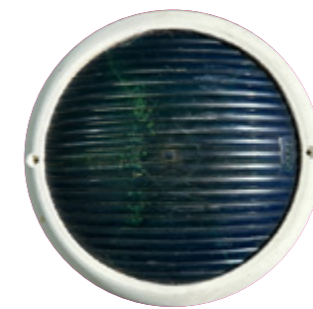

Brand Aquaquip
Model QC

Brand Aquatight
Model Aquatight Super Nova

Brand Astral
Model SLX Surface Mount / Lumipower (Zodiac)

Please contact Spa Electrics before purchasing. 🔧

Brand Davey/Monarch
Model Stroud SM400
Requires GK6710 Adaptor

Brand Dega
Model Slimline

Brand Emaux
Model Quartz Series



Brand Austin/LASWIM
Model Surface Mounted Model

Brand Autumn Solar
Model Oval

Brand Autumn Solar
Model Slim

Brand Emaux
Model E-LUMEN

Brand Emitto
Model Surface Mounted Model

Please contact Spa Electrics before purchasing. 🔧

Brand Filtrite
Model PAR56



Brand Continental Water
Model Varimode Surface Mount Light

Brand Davey/Bellson
Model PAL 4000

Brand Davey/Monarch
Model Stroud Compact 150

Brand Magic Pool Products
Model Magic Pool Light

Brand Neptune Pool Lighting
Model Retrofit/Surface Mount

Please contact Spa Electrics before purchasing. 🔧

Brand Onga
Model Delite (aka DEGA Delite)



GKRX

GKRX comes supplied with two mounting plates for Concrete (A) & Fibreglass (B) installations.

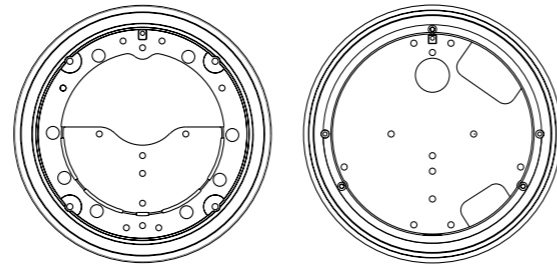
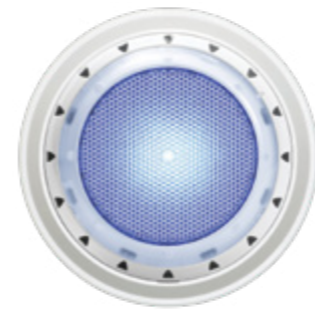

Plate A

Plate B



GKRX

RETRO KEY

⚡ Please check your transformer - **Must be 12V AC**

🔧 Please contact Spa Electrics for Installation Instructions



Please contact Spa Electrics before purchasing. 🔧

Brand Poolrite
Model Trimlite

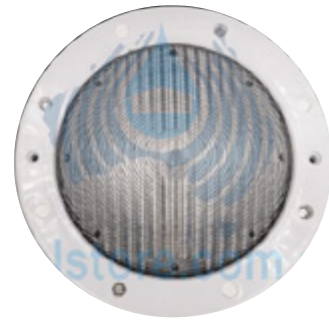

Brand Poolstore
Model Niche Light Model



Brand Prisma LED
Model PRI-POOL-XP-18W



Brand Waterco
Model Litestream Surface Mount



Brand Water TechniX
Model Vivid LED



*If there is a suction point/intake behind the light, please contact Spa Electrics.

Brand Spa Electrics
Model SE3 Halogen Model



Brand Prisma LED
Model PRI-UNI-SPA



Brand Superlight
Model SL3282, SL3284 Surface Mount Model



Brand Superlight
Model SL3255 18w Surface Mount Model

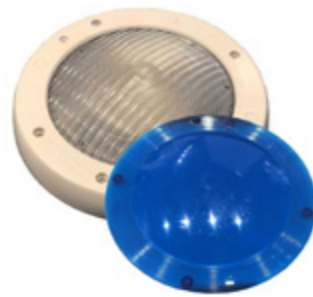

Brand Swimworld
Model Swimworld Pool Light



Brand Sunline/Rivendale
Model Surface Mounted Model



Brand Waterco
Model Britestream Surface Mounted Model

IMPORTANT NOTES

FIBREGLASS/VINYL INSTALLATIONS

Please note, for Fibreglass and Vinyl pools there are often additional steps which may include lowering the water level. Where mounting screws are used, you must lower the water level and use Neutral Curing Silicone applied to screws and in the holes to ensure it remains water tight. Special care must be taken not to remove brackets or cable glands that would compromise the pool shell/vinyl liner. Please contact Spa Electrics for detailed instructions before installing your light.

TRANSFORMERS

All* Spa Electrics Retro Fit lights require a 12V AC iron core transformer. Please check your set up prior to installing and replace transformers where necessary.

*GKRX is a multi voltage light and can function between 12-32V (AC Only)

CABLE

If the existing cable is not long enough to bring the light to the pool deck for servicing, or larger than 1.0mm² a Spa Electrics CABLE JOINER 387 and a short length of 0.5-1.0mm² cable can be used. Where a CABLE JOINER will not fit, cable can be extended using a resin cable joint.



AGRX R1

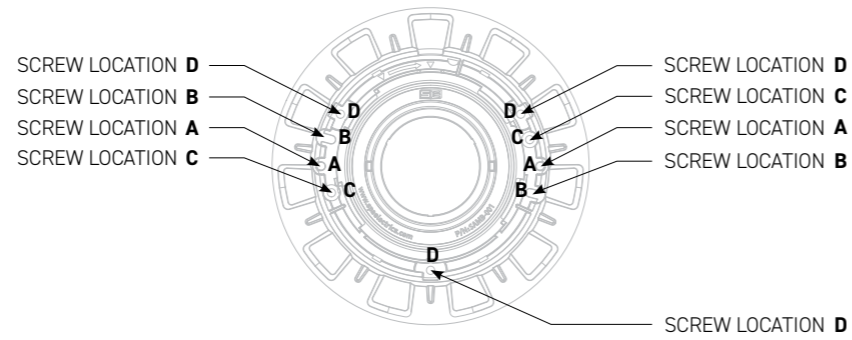

Brand	Aquaquip	Model	Aqua-Star
Construction	Fibreglass	Screw Locations	C-C
Additional Parts	AGRX 004R1 Fibreglass Only		



Brand	Aquaquip	Model	EVO / EV02
Construction	Concrete	Screw Locations	C-C
Additional Parts	AGRX 004R1 Fibreglass Only		



Brand	Aquaquip	Model	Evomax
Construction	Concrete	Screw Locations	C-C
Additional Parts			



Brand	Aquaquip	Model	Aurora
Construction	Concrete	Screw Locations	C-C
Additional Parts	AGRX 004R1 Fibreglass Only		



Brand	Astral	Model	Arc/Delta
Construction	Concrete / Fibreglass	Screw Locations	D-D-D (Trim Screw Location A)
Additional Parts	AGRX 004R1 Fibreglass Only		



AGRX R1

RETRO KEY

- Please check your transformer - **Must be 12V AC**
- Please contact Spa Electrics for Installation Instructions



Brand	Astral	Model	SLX
Construction	Concrete / Fibreglass	Screw Locations	D-D-D (Trim Screw Location A)
Additional Parts	AGRX 004R1 Fibreglass Only		



Brand	Autumn Solar	Model	Large Niche / Chameleon
Construction	Fibreglass	Screw Locations	N/A
Additional Parts	AGRX 002 + AGRX 004R1		



Brand	Spa Electrics	Model	WN150
Construction	Concrete / Fibreglass	Screw Locations	B-B
Additional Parts	AGRX 004R1 Fibreglass Only		



Brand	Sunline / Rivendale	Model	Niche Light
Construction	Concrete / Fibreglass	Screw Locations	N/A
Additional Parts	AGRX 001R1		



Brand	Waterco	Model	Britestream Slim 165
Construction	Concrete / Fibreglass	Screw Locations	N/A
Additional Parts	AGRX 002 + AGRX 004R1		



AGRX R2

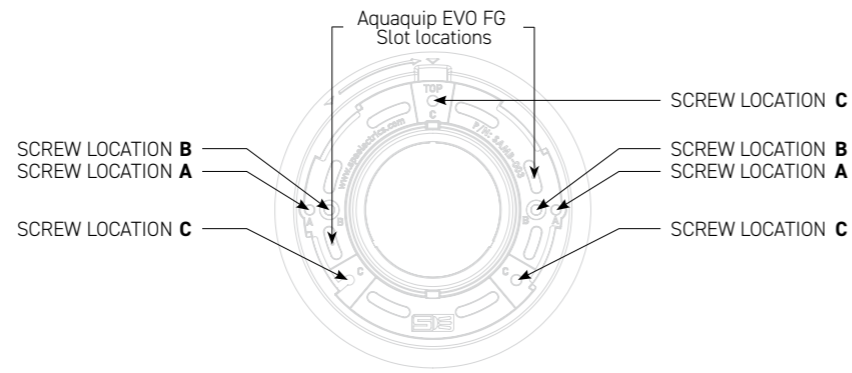

Brand	Aquaquip	Model	EVO-FG
Construction	Fibreglass	Screw Locations	See Manual

Additional Parts

Brand	Astral	Model	Calidoray
Construction	Concrete / Fibreglass	Screw Locations	N/A

Additional Parts Use Supplied Parts

Brand	Astral	Model	FLX
Construction	Fibreglass	Screw Locations	C-C-C

Additional Parts

Brand	Aqua De Light	Model	Niche Model
Construction	Concrete / Fibreglass	Screw Locations	N/A

Additional Parts AGRX 002

Brand	Autumn Solar	Model	Small Niche
Construction	Concrete / Fibreglass	Screw Locations	N/A

Additional Parts AGRX 002

Brand	Lumascap	Model	NERO NE1-3
Construction	Concrete / Fibreglass	Screw Locations	B-B

Additional Parts



AGRX R2

RETRO KEY

Please check your transformer - **Must be 12V AC**

Please contact Spa Electrics for Installation Instructions

Brand	Davey /Bellson	Model	PAL Evenglow Compact
Construction	Concrete	Screw Locations	A-A

Additional Parts

Brand	Davey /Bellson	Model	PAL Evenglow Treo Max XL
Construction	Fibreglass	Screw Locations	N/A

Additional Parts Use Supplied Parts

Brand	Davey /Bellson	Model	PAL Evenglow Fibreglass
Construction	Fibreglass	Screw Locations	N/A

Additional Parts Use Supplied Parts

Brand	Davey /Bellson	Model	PAL 2000
Construction	Concrete / Fibreglass	Screw Locations	N/A

Additional Parts Use Supplied Parts **Alternative Replacement** EMRX, pg 16.

Brand	Waterco	Model	Britestream Slim 90 C
Construction	Fibreglass	Screw Locations	N/A

Additional Parts Use Supplied Parts

Brand	Digilin	Model	Trident
Construction	Concrete / Fibreglass	Screw Locations	N/A

Additional Parts Use Supplied Parts (2x SCREW 1x8 & 2x RED WALL PLUGS)





EMRX

INCLUDED PARTS

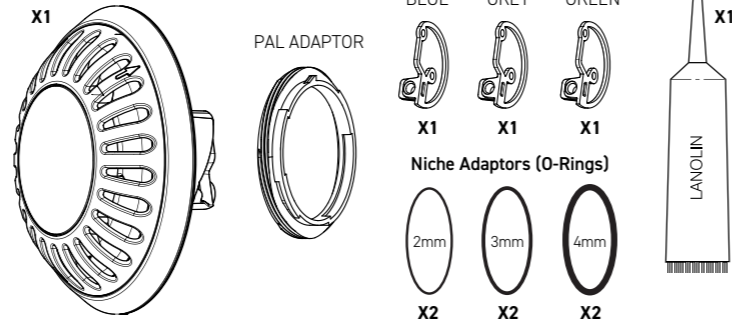

Brand	Aquaquip	Model	Aurora Compact Niche
Construction	Concrete	Additional Parts	EMRX 10 C A



Brand	EMAUX	Model	Topaz
Construction	Concrete / Fibreglass	Additional Parts	N/A



Brand	Davey	Model	SpaQuip LED
Construction	Fibreglass	Additional Parts	EMF 18



Brand	Davey/Monarch	Model	MPL 3000
Construction	Fibreglass	Additional Parts	EMRX 14



Brand	Davey	Model	PAL 2000 / PAL TOUCH
Construction	Concrete / Fibreglass	Additional Parts	Included

*AGR X R2 is the recommended replacement, see pg15.



EMRX

RETRO KEY

- Please check your transformer - **Must be 12V AC**
- Please contact Spa Electrics for Installation Instructions



Brand	Hunza	Model	Pool Lite
Construction	Concrete / Fibreglass	Additional Parts	EMRX 14



Brand	Hunza	Model	Pool Lite High Power
Construction	Concrete / Fibreglass	Additional Parts	EMRX 14



Brand	International Pool Products	Model	IPP Concrete
Construction	Concrete	Additional Parts	EMRX 18



Brand	International Pool Products	Model	IPP Fibreglass
Construction	Fibreglass	Additional Parts	EMRX 14



WNRX

RETRO KEY
 ⚡ Please check your transformer - **Must be 12V AC**
 🔧 Please contact Spa Electrics for Installation Instructions



Brand	Neptune	Model	Niche Mount
Construction	Concrete	Additional Parts	N/A



Brand	Waterco	Model	Britestream Niche 165
Construction	Concrete	Additional Parts	N/A

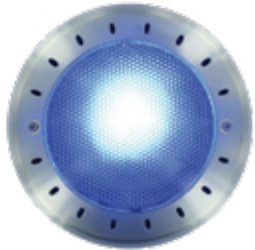

Brand	Spa Electrics	Model	WN850 / WN9
Construction	Concrete / Fibreglass	Additional Parts	N/A

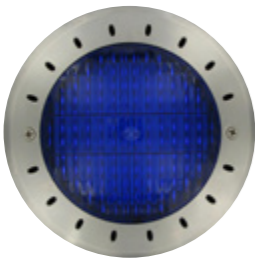

Brand	Spa Electrics	Model	WN250
Construction	Concrete / Fibreglass	Additional Parts	N/A



Brand	Emaux	Model	Zircon
Construction	Concrete	Additional Parts	N/A

ADAPTORS



*Skirt available in Clear, White & Grey

Part No.	AGRX 001R1
Description	AGRX R1 SUNLINE ADAPTOR KIT



*Skirt available in Clear, White & Grey

Part No.	AGRX 004R1
Description	AGRX R1 FIBREGLASS SKIRT



Part No.	AGRX 002
Description	AGRX R1/R2 FRICTION FIT ADAPTOR + O RINGS



Brand	EMRX 10 CA
Model	AQUASTAR ADAPTOR KIT



Brand	EMRX 18
Model	EMRX TO IPP ADAPTOR KIT - TO SUIT CONCRETE INSTALLATIONS



Brand	EMRX 14
Model	EMRX - MPL-3000 MONARCH ADAPTOR KIT



Brand	EMF 18
Model	ATOM FIBREGLASS NICHE REPLACEMENT KIT



Brand	GK6710
Model	FILTRITE (PAR 56) ADAPTOR KIT



Brand	CABLE JOINER 387
Model	INLINE PLUGGABLE CABLE JOINER - SUITS 5.5 - 12MM CABLES

TRANSFORMERS



LV25-12 SINGLE LED TRANSFORMER

- 12v AC - 25 watt transformer
- Suitable for 1 x Spa Electrics LED light
- Long life Toroidal coil transformer
- Captive terminals for easy wire termination
- Replaceable 3A blade fuse
- Mounting rail for fast installation & side by side placement
- IP44 weatherproof rating
- 12 month manufacturer's warranty



LV50-12 DUAL LED TRANSFORMER

- 12v AC - 50 watt transformer
- Suitable for 2 x Spa Electrics LED lights
- Weather protected auxiliary GPO
- Long life Toroidal coil transformer
- Captive terminals for easy wire termination
- 2 x Replaceable 3A blade fuses
- Mounting rail for fast installation & side by side placement
- IP44 weatherproof rating
- 12 month manufacturer's warranty



LV100Q-12 QUAD LED TRANSFORMER

- 12v AC - 100 watt transformer
- Suitable for 4 x Spa Electrics LED light
- Weather protected auxiliary GPO
- Long life Toroidal coil transformer
- Captive terminals for easy wire termination
- 4 Independent outputs & replaceable fuses
- Mounting rail for fast installation & side by side placement
- IP44 weatherproof rating
- 12 month manufacturer's warranty

CABLE INSTALLATION

GLAND COLOUR CODES

As pool lights are produced with varying cable sizes, every Spa Electrics Retro Series light comes supplied with a range of cable glands in order to correctly seal the cable entry point of the light. Choosing the correct size cable gland is very important so care should be taken when selecting a gland to ensure you are providing the best water seal possible.

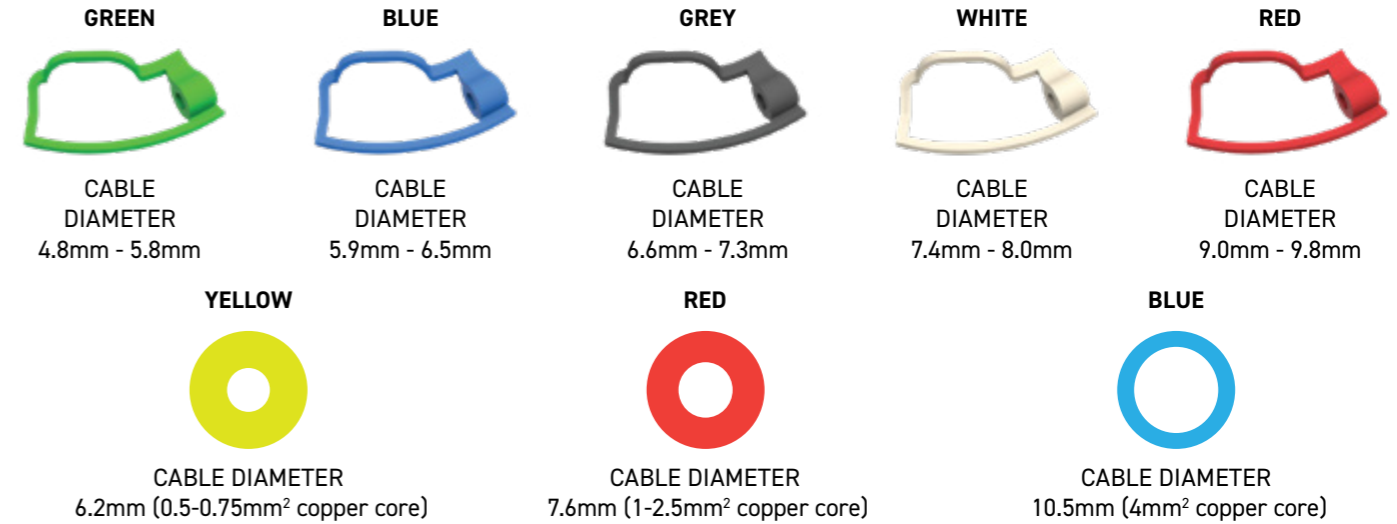

CABLE FITMENT GUIDE

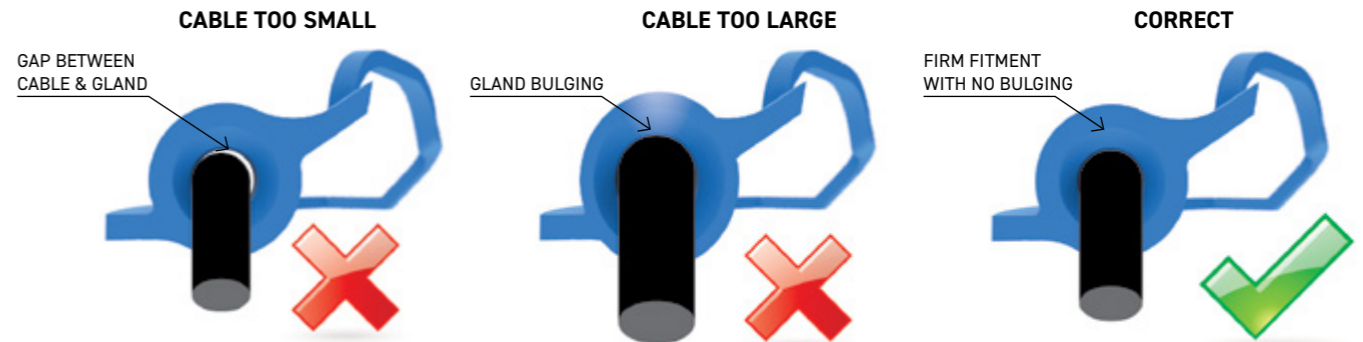

CABLE STRIPPING GUIDE

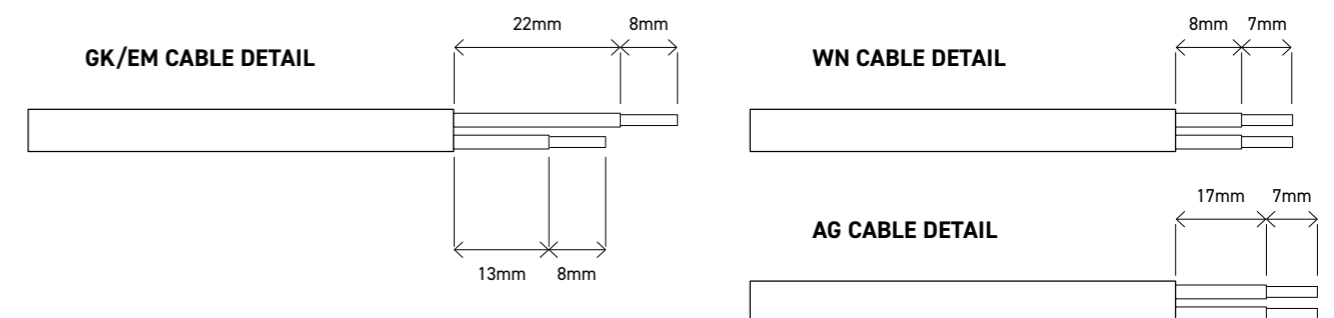

MULTIPLUS OPERATION

OVERVIEW

The MULTIPLUS LED can operate either via an iRIS Controller or simply from your standard wall switch. By default, the MULTIPLUS light will come programmed for wall switch operation so no additional setup is required to operate in this mode. To operate the MULTIPLUS light via a wall switch, please follow the below steps.

OPERATING INSTRUCTIONS

- To change the colour of the light, simply turn your light **OFF** for **2 seconds** and then turn it back **ON**. This will signal the light to proceed to the next colour in sequence. To select a desired colour, simply step through the colours until you find your desired selection.
- Your lights will automatically save your selected colour once the power has been turned **OFF** for more than 1 minute. So the next time the lights are used, they will illuminate on the last colour operated.
- To reset or 'synchronise' your lights; with the power turned **ON**, turn the power **OFF/ON** once rapidly. This will **RESET** your lights to **WHITE**.

Colours available are:

- | | | | |
|----------|------------|------------------|-----------------------|
| 1. White | 4. Magenta | 7. Green | 10. Outback Australia |
| 2. Aqua | 5. Red | 8. Oceanic Views | 11. Spring Equinox |
| 3. Blue | 6. Lime | 9. Transcendence | |

SYNCHRONISED INSTALLATION

When installing multiple lights, to ensure synchronisation and ease of operation, our pool light transformers can be daisy chained to operate from a single switch.

iRIS Lighting Controllers

For operation via remote control or mobile app, a Spa Electrics iRIS Lighting Controller can be easily fitted to any MULTIPLUS system.

For more information visit:

<https://www.spaelectrics.com.au/iris-lighting-controllers>

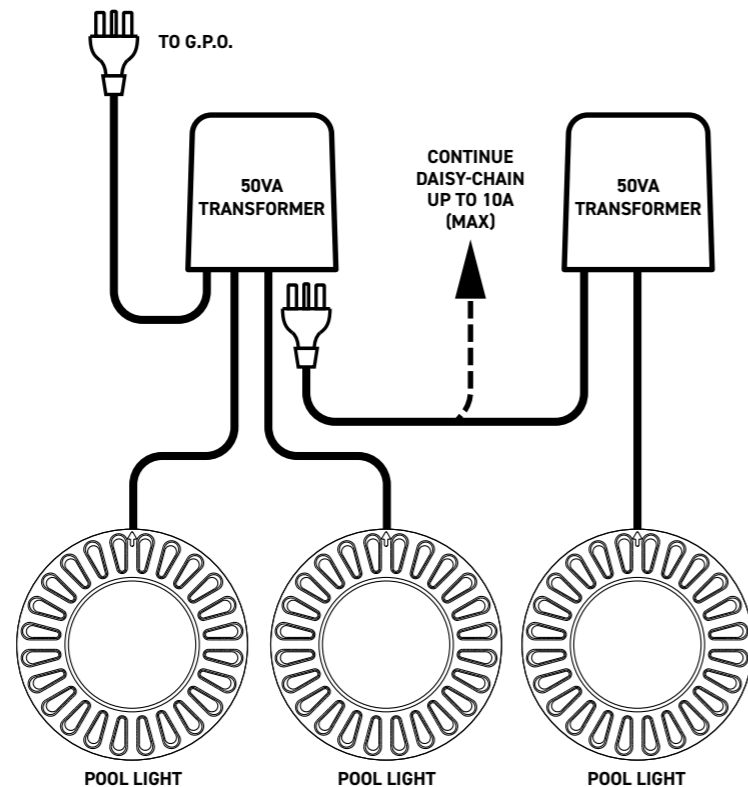

MULTIPLUS COMPATIBLE CONTROLLERS

MULTIPLUS OPERATING MODES

The MULTIPLUS light has 9 inbuilt modes of operation to allow operation on a variety of different control systems.

- 1. RED – Standalone Mode / Wall Switchmode
- 2. GREEN – Spa Electrics iRIS Mode
- 3. MAGENTA – Connect 10/SLX Mode
- 4. WHITE – Intellibrite Mode
- 5. BLUE – Spa Electrics Legacy Mode - RGB Multi
- 6. YELLOW – Hayward Mode
- 7. PINK – P-TYPE Mode (legacy)
- 8. AQUA – Jandy Mode
- 9. ORANGE – Hayward Omni-Direct Mode

CONTROLLERS / AUTOMATION SYSTEMS

AUTOMATION SYSTEM INSTALLED	SELECT LIGHT MODEL	LIGHT SETUP COLOUR
Spa Electrics iRIS	iRIS Mode	GREEN
Dontek Aquatek	iRIS Mode	GREEN
Theralux Pool + Manager	iRIS Mode	GREEN
Astral Connect 10 (2016 to current)	SLX Light	MAGENTA
Astral Connect Lite/+	SLX Light	MAGENTA
Astral Halo Lite 2/4 Halo Hub	SLX Light	MAGENTA
Pentair EasyTouch	Intellibrite Light	WHITE
Pentair IntelliTouch	Intellibrite Light	WHITE
Pentair IntelliCentre	Intellibrite Light	WHITE
Hayward Omnilogic	Universal Colourlogic	YELLOW
Jandy Aqualink RS/Z4 (F/W Rev. 'R'-Current)	Jandy LED	AQUA
Zodiac Aqualink TRI / M8	Jandy LED	AQUA
Hayward OmniDirect/OmniHUB/OmniPL	OmniDirect Mode	ORANGE

CHLORINATORS

AUTOMATION SYSTEM INSTALLED	SELECT LIGHT MODEL	LIGHT SETUP COLOUR
INSNRG Vi Chlorinator	iRIS Mode	GREEN
Astral Halo Chlor	SLX Light	MAGENTA
Astral Viron EQ Chlorinator	SLX Light	MAGENTA
Zodiac eXO iQ Chlorinator	Jandy LED	AQUA

*Astral / Dontek / INSNRG can also be used in Spa Electrics Legacy (RGB) mode.

**Halo Chlor output is DC – do not install Spa Electrics retro light directly into this unit.

MULTIPLUS ADVANCED OPERATION

SELECTING MODE OF OPERATION

The MULTIPLUS light has 9 inbuilt modes of operation to allow operation on a variety of different control systems. When you first install your MULTIPLUS light it will operate in the default, stand alone mode. In order to connect the light to a third party pool controller OR change to a different operating mode please follow the below steps.

STEP 1

If connecting to a pool automation system, please ensure the system is fully installed and you have completed all the relevant steps in the controller setup menu to operate the lights correctly. For more information on this please refer to the pool controller installation manual.

STEP 2

Ensure system has been off for 1 minute prior.

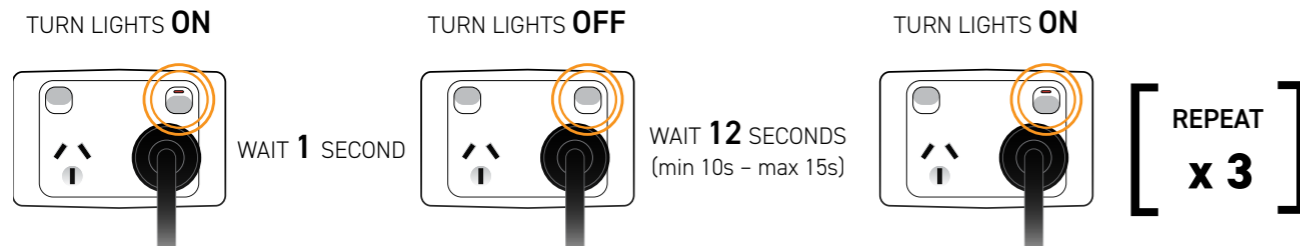

NOTE: This step can either be performed via a wall switch OR via the controller panel/Mobile App.

If installing MULTIPLUS lights with an iRIS Lighting Controller, please see iRIS installation guides.

MULTIPLUS ADVANCED OPERATION

STEP 3

After 3 ON/OFF cycles the lights will FLASH RED. This is MODE 1 (Standalone mode). Turn the lights OFF/ON to progress to the next operating mode.

- 1. RED - Standalone / Wall-Switch Mode
- 2. GREEN - Spa Electrics iRIS Mode
- 3. MAGENTA - Connect 10/SLX Mode
- 4. WHITE - Intellibrite Mode
- 5. BLUE - Spa Electrics Legacy Mode - RGB Multi
- 6. YELLOW - Hayward Mode
- 7. PINK - P-TYPE Mode (legacy)
- 8. AQUA - Jandy Mode
- 9. ORANGE - Hayward Omni-Direct Mode

STEP 4

Once the desired operating mode is selected follow the steps to save the selection.

IMPORTANT: You must wait at least 35 seconds prior to turning the system back on OR selection process will fail and setup will need to be restarted.

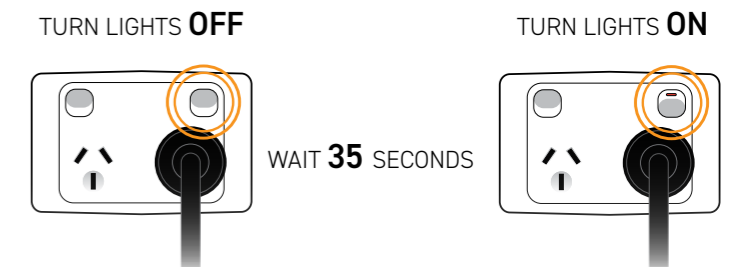

STEP 5

Your setup should now be complete. To confirm the system is working correctly, select a colour and check to ensure the correct colour is displayed.

For further assistance and troubleshooting, refer to manuals or contact Spa Electrics.

iRIS Wi-Fi (RM-WF) INSTALLATION

INSTALLATION

Plug the iRIS Controller into mains power supply.

Plug pool light transformer into outlet indicated POOL LIGHTS as per below diagram.

Plug spa light transformer into outlet indicated as SPA LIGHTS per diagram to the right.

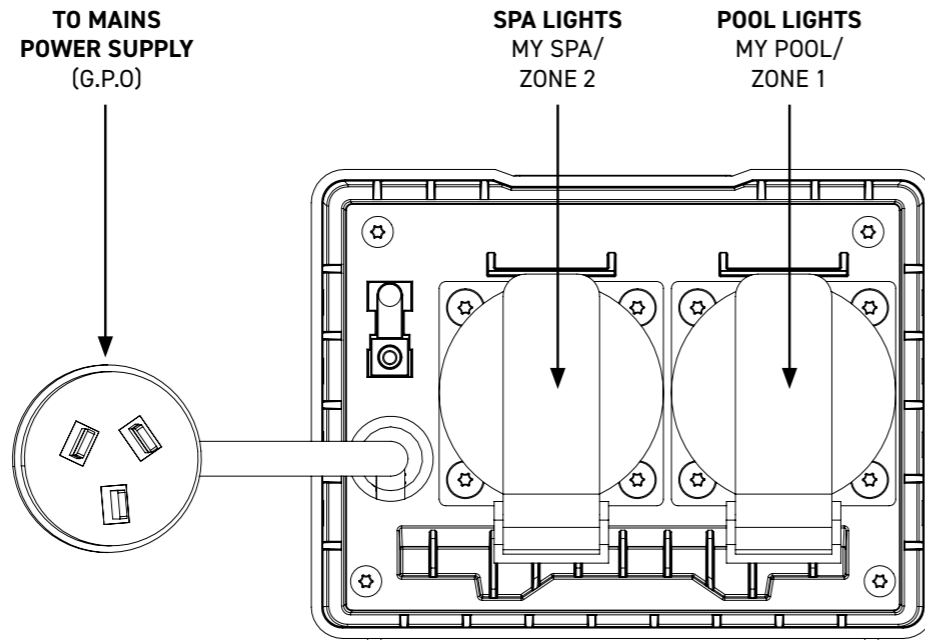

STEP 1

Download the Smart Life – Smart Living App.

Create an account or 'Try as Guest'



STEP 2

Ensure Bluetooth is enabled on your device.

Locate the Pairing Button on the bottom of the iRIS Controller.

Press and hold the pairing button for at least 5 seconds.

After holding for at least 5 seconds, release the button, the status light next to the pairing button should now be flashing.

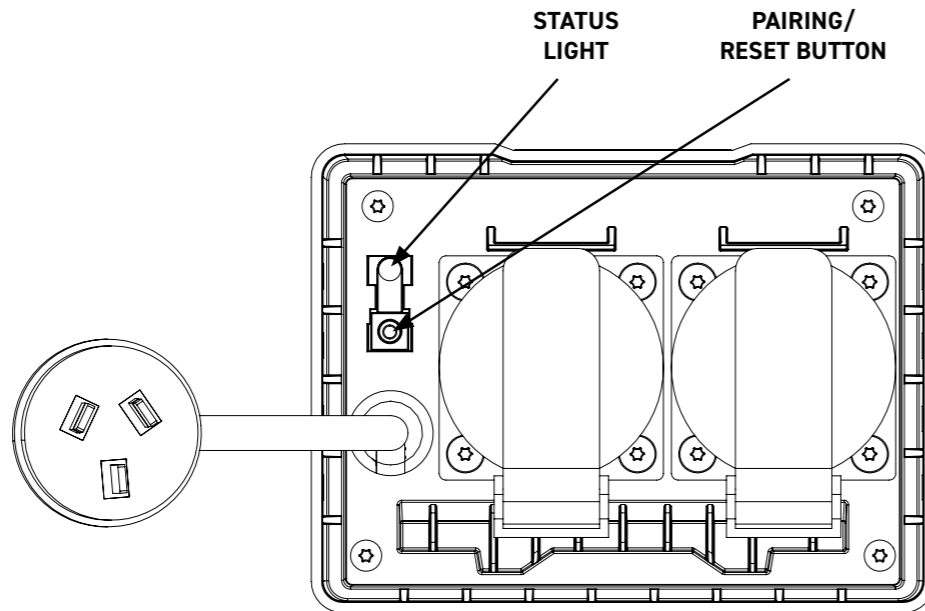

iRIS Wi-Fi (RM-WF) INSTALLATION (CONTINUED)

STEP 3

1. In the app, tap the plus **+** button in the top right corner.
2. Tap "Add Device".

STEP 4

1. Select iRIS Wi-Fi or add manually (Fig 1a : Refer to manual)
2. Enter the Network ID and Password of the Wi-Fi network you want your iRIS Controller to connect to.
3. Tap "Next".
4. Wait for the iRIS Controller to be added.
5. Once the iRIS controller has been added successfully, indicated by a green tick, Tap "Done".

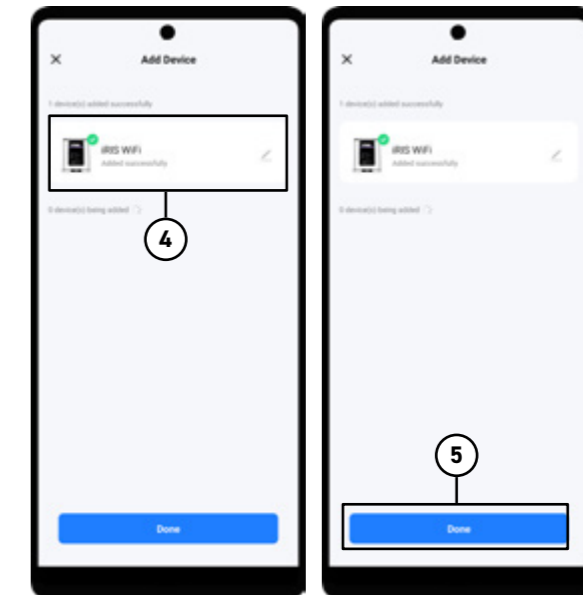
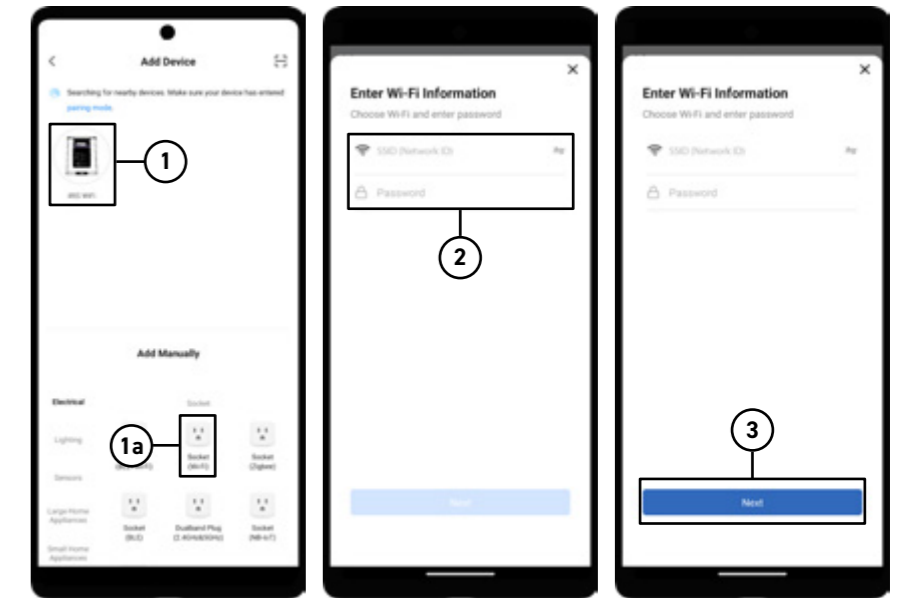

Note: If the colour selected in the app does not match the colour of the light, refer to MULTIPLUS SETUP in the iRIS Wi-Fi Manual and follow the steps to put the lights into iRIS Controller Mode.

For full user guide and trouble shooting, refer to iRIS Wi-Fi guides here:

<https://www.spaelectrics.com.au/iris-wifi-guides-landing>



iRIS REMOTE (RM-3) INSTALLATION

TRANSFORMER CONNECTION

1. Unplug pool/spa light transformers from the GPO/wall socket.
2. Plug pool transformer into the iRIS receiver socket marked 'POOL' and spa transformer or compatible product ancillary into socket marked 'SPA'.
3. Plug iRIS receiver into the GPO/wall socket.

For iRIS installation on existing pools with hardwired transformers. A qualified electrician will be required to disconnect the existing transformer from the mains supply and a plug top fitted to allow for a plugged connection to the iRIS lighting controller.

iRIS QUICK SETUP

The iRIS lighting controller has a QUICK SETUP feature to programme the MULTIPLUS lights for iRIS operation.

STEP 1: Ensure the lights have been **OFF** for a minimum of **30 seconds**, then turn the system **ON** using the iRIS Handset.

STEP 2: Press the following static colours in order with a **1 second** pause between each press.

- 2a. **WHITE**
- 2b. **RED**
- 2c. **GREEN**

If performed correctly, the lights will illuminate **GREEN**. Confirm correct operation by selecting a different colour using the Remote Handset.

REMOTE HANDSET OPERATION

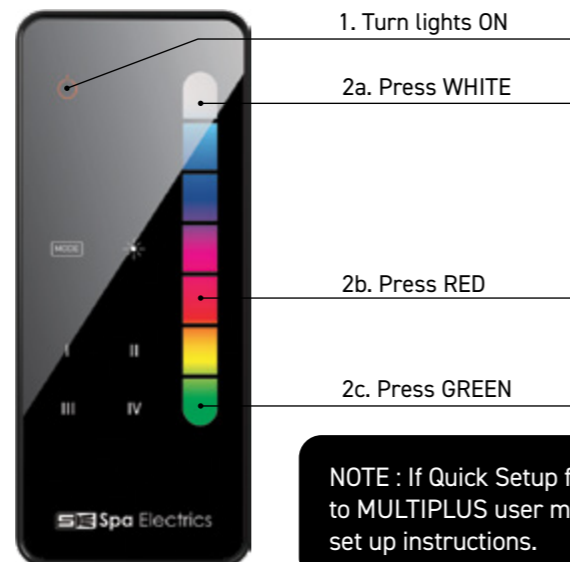
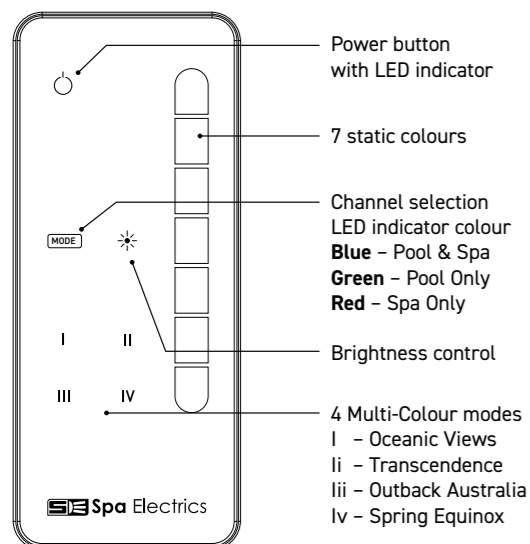

NOTE : If Quick Setup fails, refer to MULTIPLUS user manual for set up instructions.

HANDSET PAIRING

Your Remote Handset should come pre-assigned to your receiver. However if it is not paired or you would like to programme a second handset, please follow the below instructions:

STEP 1: Press the 'LEARN' button on the base of the receiver. The receiver will now switch to learning mode.

STEP 2: Within 8 seconds press 1 [one] of the buttons on the Remote Handset. The Remote Handset is now assigned to the receiver.

The receiver is capable of storing up to 2 Remote Handsets. To reset the receiver memory, press and hold the 'LEARN' button until the LED indicator light begins to flash indicating the memory has been erased. Once erased, complete steps 1 & 2 to programme the handsets.

GUIDES & MANUALS

ARGON AGRX R1/R2

<https://www.spaelectrics.com.au/agrx-guides-landing>



ATOM EMRX

<https://www.spaelectrics.com.au/emrx-guides-landing>



QUANTUM WNRX

<https://www.spaelectrics.com.au/wnrx-guides-landing>



PHOTON GKRX

<https://www.spaelectrics.com.au/gkrx-guides-landing>



IRIS WI-FI CONTROLLER RM-WF

<https://www.spaelectrics.com.au/iris-wifi-guides-landing>



IRIS REMOTE CONTROLLER RM3/RM2

<https://www.spaelectrics.com.au/rm3rm2-guides-landing>



MATRIX LED STRIP LIGHTING LSL/LWB

<https://www.spaelectrics.com.au/matrix-guides-landing>



MULTIPLUS SET UP VIDEOS MULTIPLUS

<https://www.spaelectrics.com.au/multi-plus-setup-videos>



PRODUCT CATALOGUE BROCHURES

<https://www.spaelectrics.com.au/brochures>



TECHNICAL ENQUIRIES SUPPORT

<https://www.spaelectrics.com.au/support>



COULDN'T FIND THE LIGHT YOU'RE LOOKING FOR?

OUR TECHNICAL SUPPORT TEAM IS HERE TO HELP!



STEP 1

Take photos of your existing lights & transformers



STEP 2

Contact Spa Electrics for assistance!

P 03 9793 2299

E tech@spaelectrics.com.au



PROUDLY AUSTRALIAN MADE & OWNED

All our products are designed and produced in Australia and backed by Spa Electrics' industry leading customer care network.

For more information on our products please visit:
www.spaelectrics.com.au